

W-VIEW GEMINI

Image Splitting Optics A12801-01



Technical Note

April 2017

The W-VIEW GEMINI is comprised of image splitting optics which outputs a pair of images that have been separated by wavelength using a dichroic mirror. These side-by-side images are projected onto a single camera, thereby avoiding many of the complexities that are encountered when doing dual wavelength imaging with two cameras. The W-VIEW GEMINI is a powerful tool for simultaneous two-wavelength imaging, and the purpose of this technical note is to introduce you to its features and capabilities. Detailed procedures for alignment and use are available in the instruction manual.



The W-VIEW GEMINI principle

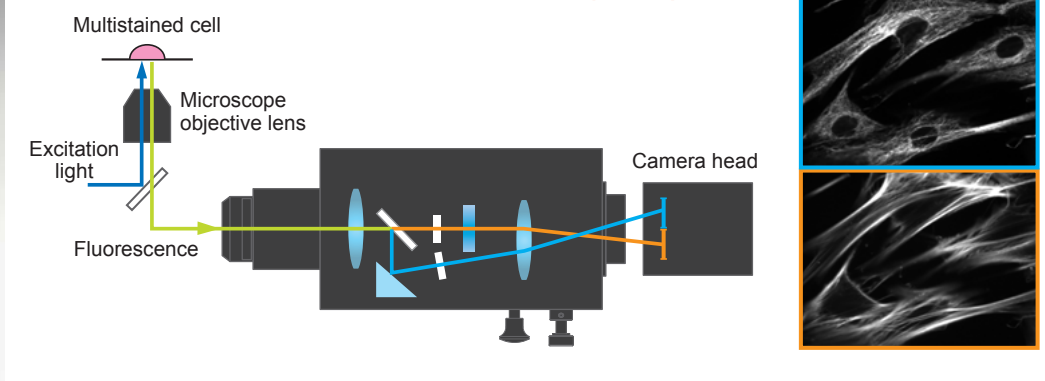

Table of contents

1 Image splitting optics

- 1-1. Image splitting optics
- 1-2. Simultaneous dual wavelength imaging by one camera

2 W-VIEW GEMINI features

- 2-1. Field of view
- 2-2. Transmittance characteristics
- 2-3. Chromatic aberration mechanism
- 2-4. Dichroic mirrors
- 2-5. Linear form factor
- 2-6. Compact size
- 2-7. Effective field of view (area)
- 2-8. Bypass mode
- 2-9. Stability
 - (1) Temperature stability
 - (2) Time stability
- 2-10. Ambient light conditions

3 Dichroic mirror and filter specifications

- 3-1. Characteristics of dichroic mirrors
- 3-2. Characteristics of bandpass filters
- 3-3. Characteristics of neutral density filters

4 Adjustment software

5 Glossary

6 Specifications

7 System configuration

8 Dimensional outlines

1 Image splitting optics

1-1. Image splitting optics

The W-VIEW GEMINI is the product from Hamamatsu for dual wavelength imaging. Its unique optical design allows for precise axial and lateral chromatic aberration correction. User selectable filters and a linear form factor with a bypass mode make it a flexible tool in the imaging laboratory.

The W-VIEW optics was developed by Dr. Kazuhiko Kinoshita (then of Keio University) and Hamamatsu employees. (Kinoshita et al., Dual-View Microscopy. The Journal of Cell Biology, Volume 115, 1991)

1-2. Simultaneous dual wavelength imaging by one camera

There are a myriad of reasons that doing simultaneous dual wavelength imaging with a single camera is simpler and more cost effective than using two cameras. In particular there's no need for complex synchronization between cameras, and there is exceptionally precise positional registration of the two images captured. And, of course, with a single camera the temporal synchronization of the image pairs is inherently perfect.

Features of W-VIEW GEMINI

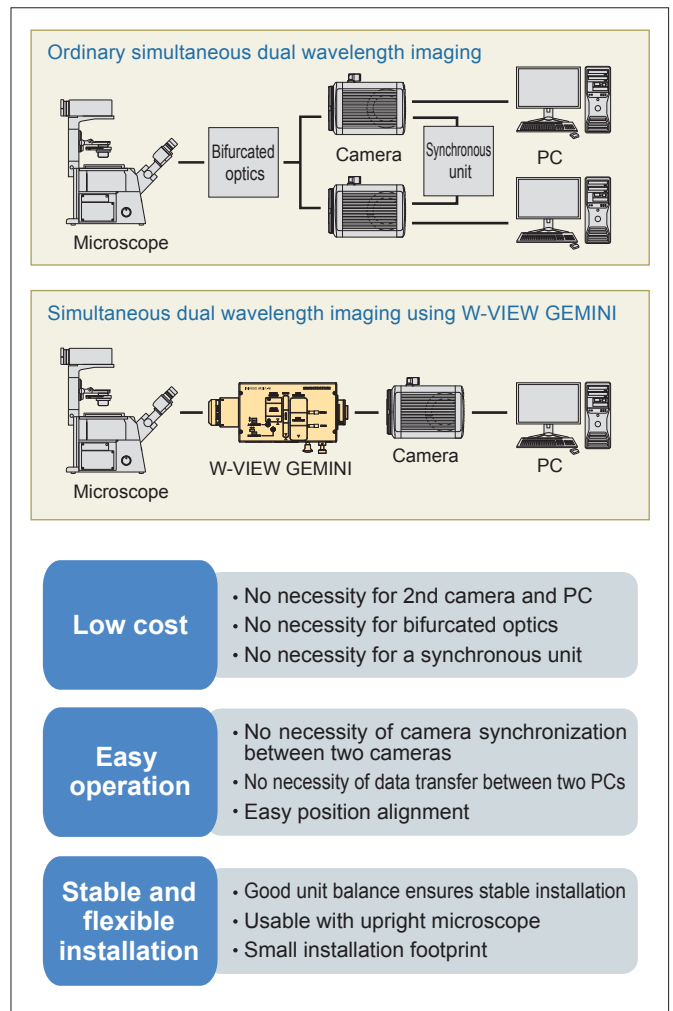

2 W-VIEW GEMINI features

2-1. Field of view

W-VIEW GEMINI was designed to take advantage of the large field of view found in modern sCMOS cameras. When using a 4.2 megapixel camera (like the ORCA-Flash4.0), each of the two wavelengths occupies 13 mm × 6.4 mm or about 2000 × 1000 pixels on the sensor. An appropriate mask for a 512 × 512 pixel camera (a common EM-CCD format) is also supplied. To help visualize the relative fields of view take a look at the image below. The solid lines represent the ORCA-Flash4.0, and the dotted lines represent an EM-CCD.

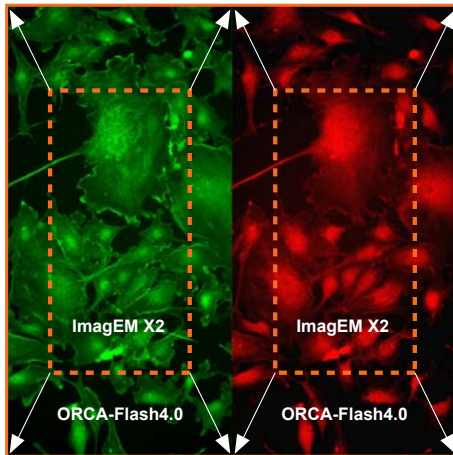

Field of view comparison between ORCA-Flash4.0 and ImagEM X2

2-2. Transmittance characteristics

By using innovative lens designs and the minimum number of optical components, the W-VIEW GEMINI has high native transmittance across a wide range of wavelengths used in fluorescence microscopy.

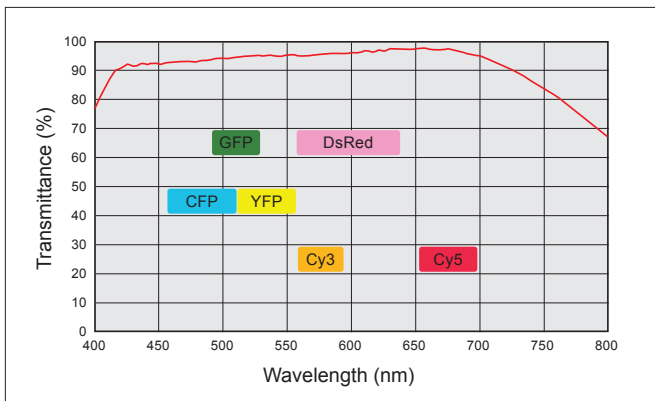

Spectral transmittance (in bypass mode)

2-3. Chromatic aberration mechanism

Lenses are designed by combining several different optical glasses, each of which has a unique refractive index that varies by wavelength. While ever so slight, these differences in refractive index combine to cause small and unavoidable

chromatic aberrations which can become problematic in demanding microscopy applications. The W-VIEW GEMINI is designed to help the user easily correct for these aberrations both in terms of wavelength dependent focus shift and zoom matching. Detailed procedures are available in the instruction manual.

2-4. Dichroic mirrors

To allow for flexible configuration commercially produced dichroic mirrors can be used in the W-VIEW GEMINI. It is important that the mirror be as flat as possible to minimize distortion, and we recommend using an “imaging grade” dichroic, which are available from several filter manufacturers. Please see section three of this document for additional details.

2-5. Linear form factor

The W-VIEW GEMINI has the input and the output C-mounts located on the same axis. This allows for stable mounting on both upright and inverted microscopes.



W-VIEW GEMINI and ORCA-Flash4.0 on an upright microscope

2-6. Compact size

The W-VIEW GEMINI's 259 mm length allows it to easily fit into the tight spaces often found in microscopy laboratories.



W-VIEW GEMINI (A12801-01) dimensions

2-7. Effective field of view (area)

The optical design of the W-VIEW GEMINI projects the two wavelengths of interest (side by side) onto a single sensor in a camera. This means that the effective size of the field of view is effectively about half the sensor size. As mentioned previously, masks for a GenII sCMOS and a 512 × 512 pixel EM-CCD are provided (6.4 mm and 3.9 mm wide respectively). The table below shows the effective fields of view with different combinations of the two masks and some common Hamamatsu cameras.

Mask unit (mm)	Camera type	Camera name	Effective field of view (mm)
6.4	sCMOS	ORCA-Flash4.0	13.3 × 13.3
	EM-CCD	ImagEM 1K, ImagEM X2-1K	13.3 × 13.3
3.9	EM-CCD	ImagEM Enhanced, ImagEM X2	8.19 × 8.19
	Cooled CCD	ORCA-R2	8.67 × 6.60

2-8. Bypass mode

Nobody likes to install and uninstall microscope parts and accessories. The W-VIEW GEMINI's bypass mode makes this unnecessary when changing from a dual to a single wavelength experiment. The steps are easy, and all of them are done without removing the W-VIEW GEMINI from the microscope. To switch to bypass mode the dichroic mirror holder, bandpass filter and correction lenses are removed and replaced with the supplied blanks. The mask unit is removed, and finally the MODE knob is pushed in, which invokes bypass mode.

Switching back to W-VIEW mode is the reverse of the steps described above followed by a quick check of the alignment using the supplied software. It is possible that you may need to adjust the mirror by a pixel or two for optimal alignment. As a last step check to make sure that the MODE knob is in the right position for the mask and camera you are currently using. Further details are available in the instruction manual.

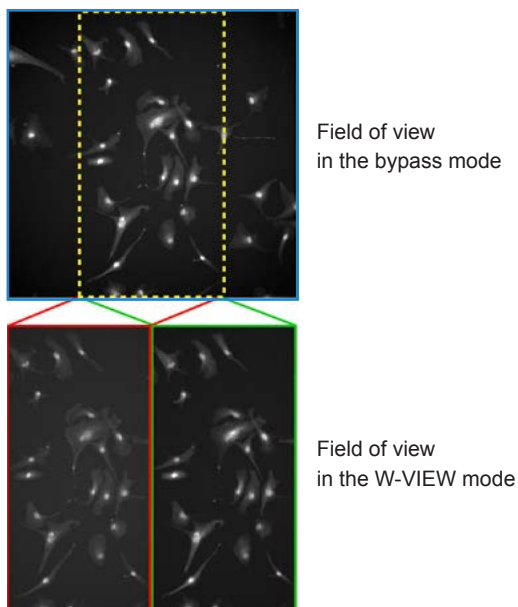

2-9. Stability

For dual wavelength imaging to be effective it is important that the alignment of the images be consistent over the duration of the experiment. The precise mechanical properties and linear design of the W-VIEW GEMINI facilitate this. Once aligned you should expect no change unless there is a very significant variation in the ambient temperature of the microscope's environment.

(1) Temperature stability

To test for temperature stability the W-VIEW GEMINI was mounted to an upright microscope with an ORCA-Flash4.0. This setup was placed in an environmental testing chamber to measure pixel misalignment as the ambient temperature changed. We varied the temperature from 22.5 °C to 27.5 °C, which was assumed to be the room temperature at which W-VIEW GEMINI would likely be used. We were unable to detect any changes down to the single pixel level.

(2) Time stability

The W-VIEW GEMINI / ORCA-Flash4.0 combination was installed on an upright microscope and then on an inverted microscope. In each case the setup was placed in a room with a constant ambient temperature of 25 °C for 7 hours. Again, we were unable to detect any changes down to the single pixel level.

2-10. Ambient light conditions

The W-VIEW GEMINI and ORCA-Flash4.0 combination was placed under a strong fluorescent light to check for light leaks. About one photon per second was detected. For most weak fluorescent imaging this would be less than typical background. Even so, we recommend turning the lights off when doing fluorescent imaging as a matter of good practice.

3 Dichroic mirror and filter specifications

3-1. Characteristics of dichroic mirrors

We recommend an imaging grade dichroic mirror for use with the W-VIEW GEMINI. As mentioned before, these are very flat and therefore have less potential to introduce distortions into the optical system. This is not an issue in typical fluorescence microscopy, but because the W-VIEW GEMINI forms an image with both the light that passes through and the light that is reflected, flatness comes into play. Poor flatness on the reflection side of the dichroic mirror distorts the wavefront, generating aberrations.

Commercial dichroic mirrors that have been designed with flatness as a priority are available. As an example, "Imaging Flatness" dichroic mirrors are available from Semrock Company. Please check with your preferred filter supplier to see if they have appropriate filters.

● Recommended examples of Semrock filters

for W-VIEW GEMINI

CFP/YFP FRET Imaging	
Bandpass Emitter 1	FF01-483/32-25
Bandpass Emitter 2	FF01-542/27-25
Dichroic mirror	FF509-FDi01-25×36

GFP/DsRED Dual Band Imaging	
Bandpass Emitter 1	FF01-512/25-25
Bandpass Emitter 2	FF01-630/92-25
Dichroic mirror	FF560-FDi01-25×36

Cy3/Cy5 FRET Imaging	
Bandpass Emitter 1	FF01-593/40-25
Bandpass Emitter 2	FF01-676/29-25
Dichroic mirror	FF640-FDi01-25×36

for Microscope

CFP/YFP FRET Imaging	
Excitation	FF02-438/24-25
Dichroic mirror	FF458-Di02-25×36
Emission	BLP01-R458-25

GFP/DsRED Dual Band Imaging	
Excitation	FF01-468/553-25
Dichroic mirror	FF493/574-Di01-25×36
Emission	FF01-512/630-25

Cy3/Cy5 FRET Imaging	
Excitation	FF01-531/40-25
Dichroic mirror	FF562-Di03-25×36
Emission	BLP02-R561-25

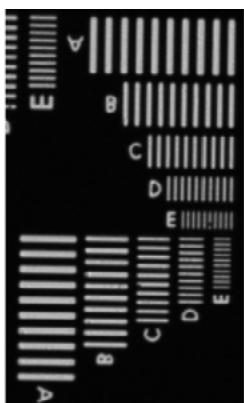

Comparison example of imaging grade dichroic mirror with non-imaging grade dichroic mirror

3-2. Characteristics of bandpass filters

The bandpass filter allows only light of specific wavelengths through. Everything else is either reflected or absorbed. Unless the bandpass filter is precisely oriented in the vertical plane relative to the axis of the impinging light, it is possible to see a "ghosting" artifact. The W-VIEW GEMINI bandpass filter holders are manufactured with great care to prevent generation of such ghosting.

For available bandpass filter sizes, see "Size of dichroic mirror and filters" under "Specifications" on page 8 of this document.

3-3. Characteristics of neutral density filters

In some dual wavelength experiments the signal from one channel is much brighter than the other. When using the W-VIEW, neutral density (ND) filters can be used to lower the amount of light of one of the wavelengths so as to match the two intensities to the exposure of the camera. Just like the bandpass filter mentioned above, the ND filter may generate ghosting if not properly oriented. As for the bandpass filter, the ND filter holder is designed to prevent ghosting.

For available ND filter sizes, see "Size of dichroic mirror and filters" under "Specifications" on page 8 of this document.

4 Adjustment software

In the W-VIEW GEMINI, images from two discrete wavelengths are projected onto the sensor of a single camera. In order for analysis of these two images to be accurate, it is important that the alignment of the optics that produces these two images is as accurate as possible. To facilitate and check this alignment the W-VIEW GEMINI comes with software that superimposes the two images and at the same time magnifies and displays the center and eight additional points towards the edges of the image. This gives the user great feedback as alignment is accomplished. You can find the software called W-VIEW Adjustment  in the DCAM directory of your computer. If you need to download DCAM, please go to <http://dcamapi.com/>.

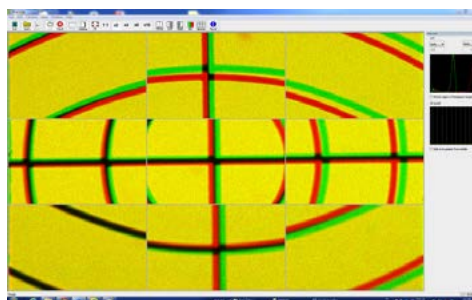

Typical view during alignment

5 Glossary

Axial chromatic aberration

Because lenses vary the refractive index according to colors (wavelengths), focal point distance and image magnification vary according to colors. This is called chromatic aberration. Of the chromatic aberrations, those involving varying the focal point distance are called axial chromatic aberration. The axial chromatic aberration, if present, affects the image focus and image resolution.

Bandpass filter

An optical element that allows only light of a specific range of wavelengths to pass. All others are reflected or absorbed. Bandpass filters sometimes transmit light that has twice the wavelength of the target wavelength. It is therefore recommended to choose a bandpass filter having transmission characteristics with wavelengths of this band completely blocked.

Bypass mode

A mode in which the dichroic mirror, bandpass filter, etc. are detached from the light path and the input light image from the microscope is formed, as it is, in the camera is called the bypass mode.

Field curvature

In taking an image using lenses, it sometimes occurs that focusing on the image center position results in the periphery slightly out of focus, and focusing on the periphery results in the center slightly out of focus. This is caused by the imaging plane not being flat due to aberration, causing the image to be formed on a curved surface. This is called the field curvature.

Dichroic mirror

An optical element that separates light into two signals by wavelength. One wavelength is reflected, and the other is transmitted. Dichroic mirrors are made by applying a special coating to a glass plate. They are available in either plates or prisms.

Distortion

Lateral chromatic aberration in which difference in lens colors give rise to differences in image magnification (size) has been already explained. Distortion means the difference in image magnification that occurs according to the image location on the imaging plane. For example, barrel distortion occurs when the periphery magnification is smaller compared to the center, whereas pincushion distortion occurs when the periphery magnification is larger compared to the center.

In the image splitting optics, the light flux is allowed to pass by an axis not parallel to the light axis of the imaging lens right before the camera, and therefore, asymmetric shape distortion occurs.

Distortion correction

Distortion is a change in the shape of an image that is a function of the geometry of an optical system. Unlike lateral chromatic aberration, it is not corrected for using the ZOOM lens of the W-VIEW GEMINI. If measurement of the image is affected by distortion, it can be corrected in post processing in many commercially available imaging software packages.

Effective field of view (area)

The W-VIEW optics projects two light images on one imaging area. The effective area is restricted by the Mask unit size so that two imaging areas do not overlap. The Mask unit size is chosen from the image format sizes of the camera.

Imaging grade

Term used to describe dichroic mirrors that are manufactured to the highest flatness tolerance.

Lateral chromatic aberration

Of chromatic aberrations, those involving varying magnifications (sizes) are called lateral chromatic aberration. The lateral chromatic aberration, if present, generates deviations when images of two colors are superimposed and therefore affects analysis results.

Relay lens magnification

The ratio of the output image size to the input image size incident to the optics. The W-VIEW GEMINI is designed to have a relay lens magnification of 1.0.

Resolution

One characteristic that describes the optics. The higher the resolution is, the finer the image obtained.

Shading

An unevenness of brightness that is dependent on location. Many factors can cause shading in images including illumination and lenses.

Spectral transmittance

The ratio of the radiating light to the light incident to the optics, which is measured by each wavelength. The larger this value is, the more effectively the light is utilized. This value is determined by the transmittance, reflectance, light collection efficiency, etc.

6 Specifications

Product name	W-VIEW GEMINI image splitting optics
Product number	A12801-01
Structure	1 camera type, C-mount to C-mount linear structure, For Uplight / Inverted microscope
Input mount	C-mount (female)
Output mount	C-mount (male)
Relay lens magnification	1.0
Field of view*1	13 mm × 6.4 mm (W-VIEW mode) 13 mm × 13 mm (Bypass mode)
Mode	W-VIEW mode / Bypass mode*2
Transmittance wavelength range*3	400 nm to 800 nm
Transmittance (Typ.)*4	97 %
Dichroic mirror*5 *6	Compatible with 25.2 × 35.6
Bandpass filter*5 *6	Compatible with φ25.4 filter
ND filter*5 *6	Compatible with φ25.4 filter
Chromatic aberration correction mechanism	Correction lens unit*7 *8 *9
Application	For fluorescence imaging with microscope
Ambient operating temperature	0 °C to +40 °C
Ambient operating humidity	70 % max. (With no condensation)
Ambient storage temperature	-10 °C to +50 °C
Ambient storage humidity	70 % max. (With no condensation)

- *1 Vignetting may occur when used with a relay lens or variable magnification lens. Please check with your Hamamatsu representative to confirm this point before purchase.
- *2 Mode in which dichroic mirror, etc. are removed from the light path and the image from the microscope is projected to the camera without alteration.
- *3 All are values in the bypass mode.
- *4 Value at peak wavelength in the bypass mode.
- *5 Because dichroic mirror, band-pass filter and ND filter are not included with the W-VIEW GEMINI, they must be purchased separately. Use an "imaging grade" dichroic mirror and bandpass filters. See "Dichroic mirror and Bandpass filter specifications".
A set which includes one Dichroic holder (empty) and one Filter holder (empty) is included with the W-VIEW GEMINI. Additional sets can be purchased by ordering part number A12802-01.
- *6 For the usable size, see "Size of dichroic mirror and filters".
- *7 This is to improve the magnification difference caused by chromatic aberration. The position difference of two wavelength images caused by the distortion aberration is not improved.
- *8 Since the FOCUS knob is designed to improve the axial chromatic aberration caused by this optics, its effect is very limited.
- *9 Dual focal plane imaging is not possible.

Accessories

Mask unit (6.4 mm), Mask unit (3.9 mm), Correction lens unit, Dichroic holder (empty), Filter holder (empty), Mask unit cover, Correction lens cover, Dichroic cover, Filter cover, C-mount cap (male), C-mount cap (female), Hex driver (2.5 mm), Hex driver (1.5 mm), Concentric chart, Filter jig, Format adjustment jig, Accessory storage case, Instruction manual (CD), User guide "Read before use"

*No dichroic mirror, no bandpass filter and no ND filter are attached to W-VIEW GEMINI, and users are requested to procure them by themselves.

- ORCA is registered trademark of Hamamatsu Photonics K.K. (France, Germany, Japan, U.K., U.S.A.)
- HCIMAGE is registered trademark of PHOTONICS MANAGEMENT CORP. (Australia, China, EU, Japan, Norway, Singapore, Switzerland, U.S.A.)
- Product and software package names noted in this documentation are trademarks or registered trademarks of their respective manufacturers.
- Subject to local technical requirements and regulations, availability of products included in this promotional material may vary. Please consult your local sales representative.
- Information furnished by HAMAMATSU is believed to be reliable. However, no responsibility is assumed for possible inaccuracies or omissions.

Specifications and external appearance are subject to change without notice.

© 2017 Hamamatsu Photonics K.K.

HAMAMATSU PHOTONICS K.K. www.hamamatsu.com

HAMAMATSU PHOTONICS K.K., Systems Division

812 Joko-cho, Higashi-ku, Hamamatsu City, 431-3196, Japan, Telephone: (81)53-431-0124, Fax: (81)53-435-1574, E-mail: export@sys.hpk.co.jp

U.S.A.: Hamamatsu Corporation, 360 Foothill Road, Bridgewater, NJ 08807, U.S.A., Telephone: (1)908-231-0960, Fax: (1)908-231-1218 E-mail: usa@hamamatsu.com

Germany: Hamamatsu Photonics Deutschland GmbH, Arzbergerstr. 10, D-82211 Herrsching am Ammersee, Germany, Telephone: (49)8152-375-0, Fax: (49)8152-265-8 E-mail: info@hamamatsu.de

France: Hamamatsu Photonics France S.A.R.L., 19, Rue du Saule Trapu, Parc du Moulin de Massy, 91882 Massy Cedex, France, Telephone: (33)1 69 53 71 00, Fax: (33)1 69 53 71 10 E-mail: infos@hamamatsu.fr

United Kingdom: Hamamatsu Photonics UK Limited, 2 Howard Court, 10 Tewin Road, Welwyn Garden City, Hertfordshire AL7 1BW, UK, Telephone: (44)1707-294888, Fax: (44)1707-325777 E-mail: info@hamamatsu.co.uk

North Europe: Hamamatsu Photonics Norden AB, Torshamnsgatan 35 16440 Kista, Sweden, Telephone: (46)8-509-031-00, Fax: (46)8-509-031-01 E-mail: info@hamamatsu.se

Italy: Hamamatsu Photonics Italia S.r.l., Strada della Moia, 1 int. 6, 20020 Arese (Milano), Italy, Telephone: (39)02-935-81-733, Fax: (39)02-935-81-741 E-mail: info@hamamatsu.it

China: Hamamatsu Photonics (China) Co., Ltd., 1201 Tower B, Jiaming Center, 27 Dongsanhuan Beilu, Chaoyang District, 100020 Beijing, China, Telephone: (86)10-6586-6006, Fax: (86)10-6586-2866 E-mail: hpc@hamamatsu.com.cn

Taiwan: Hamamatsu Photonics Taiwan Co., Ltd., 8F-3, No.158, Section2, Gongdao 5th Road, East District, Hsinchu, 300, Taiwan R.O.C. Telephone: (886)03-659-0080, Fax: (886)07-811-7238 E-mail: info@tw.hpk.co.jp

Cat. No. SBIS0101E02
APR/2017 HPK
Created in Japan

Size of dichroic mirror and filters

	Size (mm) / Tolerances (mm)		Thickness (mm)
Dichroic mirror	25.1×35.5 to 26.1×38.1		0.9 to 2.1
Bandpass filter	φ25.4	+0/-0.6	Short wavelength 5.0(Max.)* Long wavelength 6.0(Max.)*
ND filter			

*The value is total thickness of a bandpass filter and ND filter.

7 System configuration

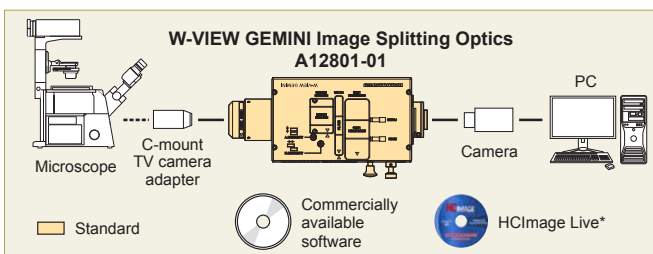

* HCImage Live software provides standard image measurement functions.

Options

Model name	Product name
A12802-01	Holder set for image splitting optics for A12801-01 *1
A12802-02	Mask unit with grid chart 6.4 mm for A12801-01
A12802-03	Mask unit with grid chart 3.9 mm for A12801-01
A12802-04	Cube beamsplitter holder for A12801-01
A12964-01	Adjuster for A12801-01 *2

- *1 A12802-01 includes a Dichroic holder (empty) and a Filter holder (empty).
*2 A12964-01 is the height adjustable stand inserted between the floor and W-VIEW GEMINI bottom.
Adjustable height range:
Vertical installation: 10 mm to 36 mm Horizontal installation: 32 mm to 59 mm

8 Dimensional outlines

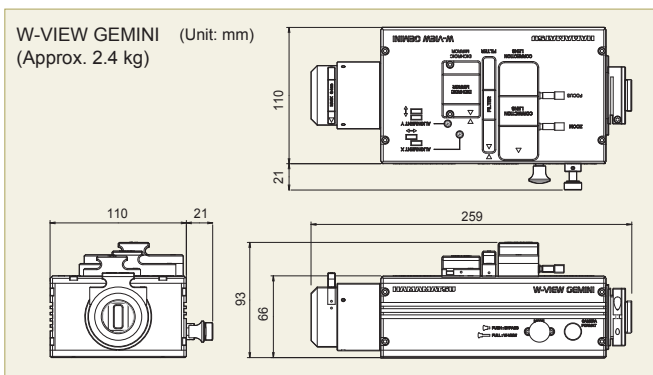

- ORCA is registered trademark of Hamamatsu Photonics K.K. (France, Germany, Japan, U.K., U.S.A.)
- HCIMAGE is registered trademark of PHOTONICS MANAGEMENT CORP. (Australia, China, EU, Japan, Norway, Singapore, Switzerland, U.S.A.)
- Product and software package names noted in this documentation are trademarks or registered trademarks of their respective manufacturers.
- Subject to local technical requirements and regulations, availability of products included in this promotional material may vary. Please consult your local sales representative.
- Information furnished by HAMAMATSU is believed to be reliable. However, no responsibility is assumed for possible inaccuracies or omissions.

Specifications and external appearance are subject to change without notice.

© 2017 Hamamatsu Photonics K.K.

HAMAMATSU PHOTONICS K.K. www.hamamatsu.com

HAMAMATSU PHOTONICS K.K., Systems Division

812 Joko-cho, Higashi-ku, Hamamatsu City, 431-3196, Japan, Telephone: (81)53-431-0124, Fax: (81)53-435-1574, E-mail: export@sys.hpk.co.jp

U.S.A.: Hamamatsu Corporation, 360 Foothill Road, Bridgewater, NJ 08807, U.S.A., Telephone: (1)908-231-0960, Fax: (1)908-231-1218 E-mail: usa@hamamatsu.com

Germany: Hamamatsu Photonics Deutschland GmbH, Arzbergerstr. 10, D-82211 Herrsching am Ammersee, Germany, Telephone: (49)8152-375-0, Fax: (49)8152-265-8 E-mail: info@hamamatsu.de

France: Hamamatsu Photonics France S.A.R.L., 19, Rue du Saule Trapu, Parc du Moulin de Massy, 91882 Massy Cedex, France, Telephone: (33)1 69 53 71 00, Fax: (33)1 69 53 71 10 E-mail: infos@hamamatsu.fr

United Kingdom: Hamamatsu Photonics UK Limited, 2 Howard Court, 10 Tewin Road, Welwyn Garden City, Hertfordshire AL7 1BW, UK, Telephone: (44)1707-294888, Fax: (44)1707-325777 E-mail: info@hamamatsu.co.uk

North Europe: Hamamatsu Photonics Norden AB, Torshamnsgatan 35 16440 Kista, Sweden, Telephone: (46)8-509-031-00, Fax: (46)8-509-031-01 E-mail: info@hamamatsu.se

Italy: Hamamatsu Photonics Italia S.r.l., Strada della Moia, 1 int. 6, 20020 Arese (Milano), Italy, Telephone: (39)02-935-81-733, Fax: (39)02-935-81-741 E-mail: info@hamamatsu.it

China: Hamamatsu Photonics (China) Co., Ltd., 1201 Tower B, Jiaming Center, 27 Dongsanhuan Beilu, Chaoyang District, 100020 Beijing, China, Telephone: (86)10-6586-6006, Fax: (86)10-6586-2866 E-mail: hpc@hamamatsu.com.cn

Taiwan: Hamamatsu Photonics Taiwan Co., Ltd., 8F-3, No.158, Section2, Gongdao 5th Road, East District, Hsinchu, 300, Taiwan R.O.C. Telephone: (886)03-659-0080, Fax: (886)07-811-7238 E-mail: info@tw.hpk.co.jp

Cat. No. SBIS0101E02
APR/2017 HPK
Created in Japan